

Kalibrierter Hochleistungs-Breitband-Balun
Calibrated High Power Broadband Balun



Beschreibung:

Hochleistungs Guanella-Balun 4:1 auf PTFE-Wickelkörper mit 10 mm Spannzangen zur Elementaufnahme.

Description:

High Power Guanella Balun 4:1 on PTFE body with 10 mm element fixtures.

Technische Daten:		Specifications:
Frequenzbereich:	20 ... 200 MHz	<i>Frequency Range:</i>
Nominelle Impedanz:	50 Ω	<i>Nominal Impedance:</i>
Antennenwandlungsmaß: (abhängig vom Elementtyp und Frequenzbereich)	typ. 4-18 dB/m (BBAL 9136)	<i>Antenna Factor: (depending on elem. type in use and frequency range)</i>
Länge Halterung:	LH=660 mm	<i>Length holder:</i>
Breite: je nach Elementtyp (siehe Tabelle Zubehör)		<i>Width depends on elements used (see table accessories below)</i>
Antennenschaft (Halterungsrohr)	Ø 22 mm	<i>Antenna shaft (Tube):</i>
Gewicht:	2.2 kg	<i>Weight:</i>
Koaxialanschluß (Buchse):	N 7/16	<i>Coaxial Connector (female):</i>

Empfohlenes Zubehör:		Recommended Accessories:
BBAL 9136 Bikonus-Elemente	LE=1.98 m, D=0.5 m	BBAL 9136 Biconical Elements
BBFA 9146 Faltbikonus-Elemente	LE & D variabel	BBFA 9146 Collapsible Biconical Elements

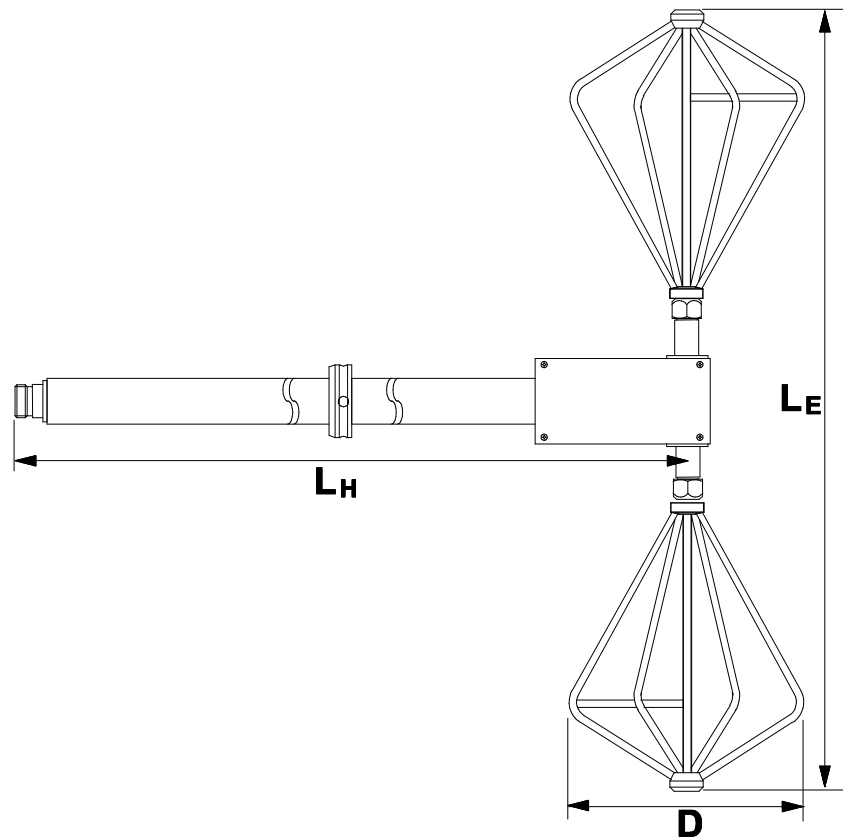

Hochleistungs-Breitband Balun / Halter VHBD 9134 + BBAL 9136 Elemente
High Power Broadband Balun / Holder VHBD 9134 + BBAL 9136 Elements

Frequency	Distance	Wavelength	Attenuation	Gain(Isotr.)	Gain(Dipole)	Ant.-Factor
MHz	m	m	dB	dBi	dBd	dB/m
20.00	1.00	15.00	20.06	-10.80	-12.95	7.04
21.00	1.00	14.29	19.85	-10.48	-12.63	7.15
22.00	1.00	13.64	19.97	-10.34	-12.49	7.41
23.00	1.00	13.04	20.13	-10.22	-12.38	7.68
24.00	1.00	12.50	19.98	-9.96	-12.12	7.79
25.00	1.00	12.00	19.93	-9.77	-11.92	7.94
26.00	1.00	11.54	20.30	-9.78	-11.93	8.30
27.00	1.00	11.11	20.52	-9.73	-11.88	8.57
28.00	1.00	10.71	20.39	-9.50	-11.65	8.66
29.00	1.00	10.34	20.33	-9.32	-11.47	8.79
30.00	1.00	10.00	20.54	-9.28	-11.43	9.04
31.00	1.00	9.68	20.36	-9.05	-11.20	9.09
32.00	1.00	9.38	19.71	-8.58	-10.73	8.90
33.00	1.00	9.09	19.41	-8.30	-10.45	8.89
34.00	1.00	8.82	19.43	-8.18	-10.33	9.03
35.00	1.00	8.57	19.21	-7.94	-10.09	9.04
36.00	1.00	8.33	18.47	-7.45	-9.60	8.80
37.00	1.00	8.11	17.81	-7.00	-9.15	8.59
38.00	1.00	7.89	17.68	-6.82	-8.97	8.64
39.00	1.00	7.69	17.28	-6.51	-8.66	8.55
40.00	1.00	7.50	16.48	-6.00	-8.15	8.26
41.00	1.00	7.32	15.89	-5.60	-7.75	8.07
42.00	1.00	7.14	15.41	-5.25	-7.40	7.94
43.00	1.00	6.98	14.87	-4.87	-7.03	7.76
44.00	1.00	6.82	14.33	-4.51	-6.66	7.60
45.00	1.00	6.67	14.58	-4.54	-6.69	7.82
46.00	1.00	6.52	15.66	-4.98	-7.13	8.45
47.00	1.00	6.38	15.50	-4.81	-6.96	8.47
48.00	1.00	6.25	14.25	-4.09	-6.24	7.93
49.00	1.00	6.12	13.48	-3.62	-5.77	7.64
50.00	1.00	6.00	13.50	-3.54	-5.69	7.74
51.00	1.00	5.88	12.67	-3.03	-5.18	7.41
52.00	1.00	5.77	11.44	-2.34	-4.49	6.88
53.00	1.00	5.66	10.71	-1.89	-4.04	6.59
54.00	1.00	5.56	10.35	-1.63	-3.78	6.49
55.00	1.00	5.45	9.87	-1.31	-3.46	6.34
56.00	1.00	5.36	9.59	-1.09	-3.24	6.27
57.00	1.00	5.26	9.40	-0.92	-3.07	6.25
58.00	1.00	5.17	9.26	-0.77	-2.92	6.26
59.00	1.00	5.08	8.97	-0.55	-2.70	6.19
60.00	1.00	5.00	8.90	-0.44	-2.59	6.23
61.00	1.00	4.92	8.94	-0.39	-2.54	6.32
62.00	1.00	4.84	8.97	-0.34	-2.49	6.41
63.00	1.00	4.76	8.94	-0.25	-2.41	6.46
64.00	1.00	4.69	9.07	-0.25	-2.40	6.59
65.00	1.00	4.62	9.34	-0.32	-2.47	6.79
66.00	1.00	4.55	9.40	-0.28	-2.43	6.89
67.00	1.00	4.48	9.57	-0.30	-2.45	7.04
68.00	1.00	4.41	9.85	-0.38	-2.53	7.25
69.00	1.00	4.35	10.25	-0.51	-2.66	7.51

Hochleistungs-Breitband Balun / Halter VHBD 9134 + BBAL 9136 Elemente
High Power Broadband Balun / Holder VHBD 9134 + BBAL 9136 Elements

Frequency	Distance	Wavelength	Attenuation	Gain(Isotr.)	Gain(Dipole)	Ant.-Factor
MHz	m	m	dB	dBi	dBd	dB/m
70.00	1.00	4.29	10.36	-0.51	-2.66	7.63
71.00	1.00	4.23	10.53	-0.53	-2.68	7.78
72.00	1.00	4.17	10.79	-0.60	-2.75	7.97
73.00	1.00	4.11	11.18	-0.73	-2.89	8.22
74.00	1.00	4.05	11.36	-0.76	-2.91	8.37
75.00	1.00	4.00	11.57	-0.81	-2.96	8.53
76.00	1.00	3.95	11.99	-0.96	-3.11	8.80
77.00	1.00	3.90	12.37	-1.10	-3.25	9.05
78.00	1.00	3.85	12.51	-1.11	-3.26	9.17
79.00	1.00	3.80	12.51	-1.05	-3.20	9.23
80.00	1.00	3.75	12.76	-1.12	-3.27	9.40
81.00	1.00	3.70	12.97	-1.18	-3.33	9.57
82.00	1.00	3.66	12.94	-1.11	-3.26	9.61
83.00	1.00	3.61	12.87	-1.02	-3.17	9.62
84.00	1.00	3.57	13.12	-1.09	-3.24	9.80
85.00	1.00	3.53	13.34	-1.15	-3.30	9.96
86.00	1.00	3.49	13.44	-1.15	-3.30	10.06
87.00	1.00	3.45	13.53	-1.15	-3.30	10.16
88.00	1.00	3.41	13.69	-1.17	-3.33	10.28
89.00	1.00	3.37	13.89	-1.22	-3.38	10.43
90.00	1.00	3.33	14.01	-1.24	-3.39	10.54
91.00	1.00	3.30	14.10	-1.23	-3.38	10.63
92.00	1.00	3.26	14.20	-1.24	-3.39	10.74
93.00	1.00	3.23	14.34	-1.26	-3.41	10.85
94.00	1.00	3.19	14.35	-1.22	-3.37	10.90
95.00	1.00	3.16	14.41	-1.20	-3.35	10.98
96.00	1.00	3.12	14.45	-1.18	-3.33	11.05
97.00	1.00	3.09	14.61	-1.21	-3.36	11.17
98.00	1.00	3.06	14.51	-1.12	-3.27	11.16
99.00	1.00	3.03	14.42	-1.03	-3.18	11.16
100.00	1.00	3.00	14.41	-0.98	-3.13	11.20
105.00	1.00	2.86	14.33	-0.73	-2.88	11.37
110.00	1.00	2.73	14.10	-0.41	-2.56	11.46
115.00	1.00	2.61	14.12	-0.23	-2.38	11.66
120.00	1.00	2.50	14.20	-0.08	-2.23	11.89
125.00	1.00	2.40	14.40	-0.01	-2.16	12.17
130.00	1.00	2.31	14.63	0.05	-2.10	12.45
135.00	1.00	2.22	15.18	-0.06	-2.21	12.89
140.00	1.00	2.14	15.80	-0.21	-2.36	13.35
145.00	1.00	2.07	16.63	-0.48	-2.63	13.92
150.00	1.00	2.00	18.40	-1.22	-3.37	14.96
155.00	1.00	1.94	19.23	-1.49	-3.64	15.51
160.00	1.00	1.87	19.65	-1.56	-3.71	15.86
165.00	1.00	1.82	20.24	-1.72	-3.87	16.29
170.00	1.00	1.76	20.63	-1.79	-3.94	16.62
175.00	1.00	1.71	21.41	-2.05	-4.20	17.13
180.00	1.00	1.67	22.00	-2.22	-4.38	17.55
185.00	1.00	1.62	22.37	-2.29	-4.44	17.85
190.00	1.00	1.58	23.53	-2.75	-4.90	18.55
195.00	1.00	1.54	23.44	-2.59	-4.74	18.61
200.00	1.00	1.50	25.47	-3.50	-5.65	19.74



Hochleistungs-Breitband Balun / Halter VHBD 9134 + BBAL 9136 Elemente
High Power Broadband Balun / Holder VHBD 9134 + BBAL 9136 Elements

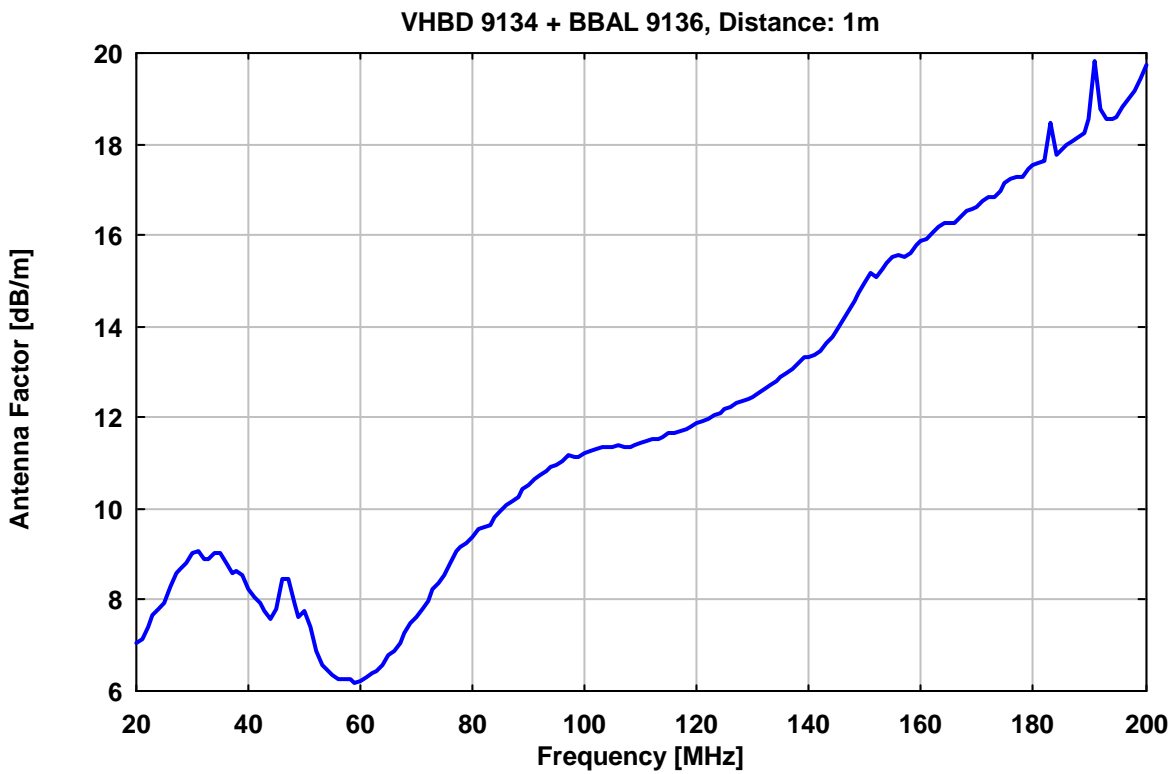
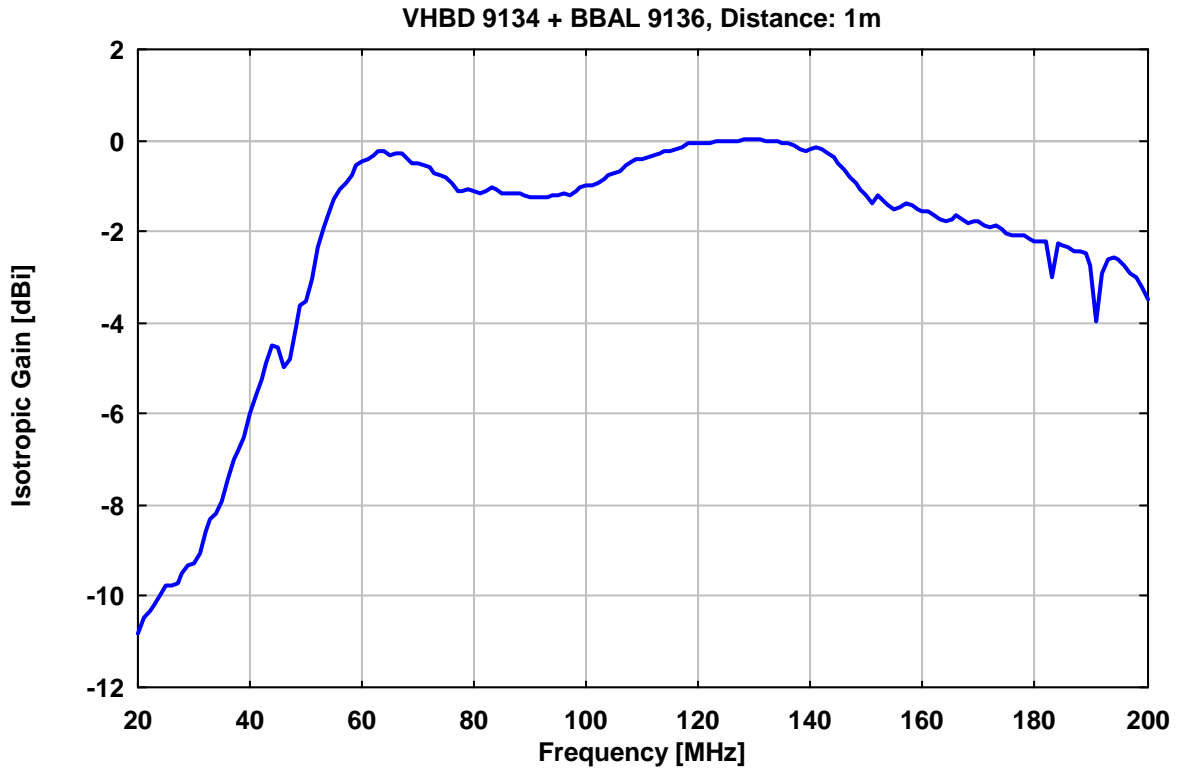

Hochleistungs-Breitband Balun / Halter VHBD 9134 + BBAL 9136 Elemente
High Power Broadband Balun / Holder VHBD 9134 + BBAL 9136 Elements

Frequency	Distance	Wavelength	Attenuation	Gain(Isotr.)	Gain(Dipole)	Ant.-Factor
MHz	m	m	dB	dBi	dBd	dB/m
20.00	3.00	15.00	38.48	-15.24	-17.39	11.48
21.00	3.00	14.29	36.90	-14.23	-16.38	10.90
22.00	3.00	13.64	35.47	-13.32	-15.47	10.39
23.00	3.00	13.04	34.42	-12.60	-14.75	10.06
24.00	3.00	12.50	33.26	-11.84	-13.99	9.66
25.00	3.00	12.00	32.32	-11.19	-13.34	9.37
26.00	3.00	11.54	32.04	-10.88	-13.03	9.40
27.00	3.00	11.11	31.67	-10.53	-12.68	9.38
28.00	3.00	10.71	30.83	-9.95	-12.10	9.11
29.00	3.00	10.34	30.00	-9.38	-11.54	8.85
30.00	3.00	10.00	29.51	-8.99	-11.14	8.75
31.00	3.00	9.68	28.72	-8.45	-10.60	8.50
32.00	3.00	9.38	27.46	-7.69	-9.84	8.01
33.00	3.00	9.09	26.69	-7.17	-9.32	7.76
34.00	3.00	8.82	26.39	-6.89	-9.04	7.74
35.00	3.00	8.57	26.03	-6.58	-8.73	7.69
36.00	3.00	8.33	25.20	-6.04	-8.19	7.39
37.00	3.00	8.11	24.15	-5.40	-7.55	6.98
38.00	3.00	7.89	23.78	-5.10	-7.25	6.91
39.00	3.00	7.69	23.38	-4.79	-6.94	6.83
40.00	3.00	7.50	22.30	-4.14	-6.29	6.40
41.00	3.00	7.32	21.60	-3.68	-5.83	6.16
42.00	3.00	7.14	20.86	-3.20	-5.35	5.89
43.00	3.00	6.98	20.03	-2.69	-4.84	5.58
44.00	3.00	6.82	19.48	-2.31	-4.46	5.40
45.00	3.00	6.67	19.67	-2.31	-4.46	5.60
46.00	3.00	6.52	20.64	-2.70	-4.85	6.17
47.00	3.00	6.38	21.01	-2.79	-4.94	6.45
48.00	3.00	6.25	20.57	-2.48	-4.63	6.32
49.00	3.00	6.12	18.90	-1.56	-3.71	5.58
50.00	3.00	6.00	18.71	-1.37	-3.52	5.57
51.00	3.00	5.88	18.34	-1.10	-3.25	5.47
52.00	3.00	5.77	17.71	-0.70	-2.85	5.24
53.00	3.00	5.66	16.88	-0.20	-2.35	4.91
54.00	3.00	5.56	16.60	0.02	-2.14	4.85
55.00	3.00	5.45	16.17	0.31	-1.84	4.72
56.00	3.00	5.36	15.78	0.58	-1.57	4.60
57.00	3.00	5.26	15.77	0.67	-1.48	4.67
58.00	3.00	5.17	16.12	0.57	-1.58	4.92
59.00	3.00	5.08	15.94	0.73	-1.42	4.91
60.00	3.00	5.00	15.77	0.89	-1.26	4.89
61.00	3.00	4.92	15.79	0.95	-1.20	4.98
62.00	3.00	4.84	15.72	1.06	-1.10	5.01
63.00	3.00	4.76	15.45	1.26	-0.89	4.95
64.00	3.00	4.69	15.45	1.33	-0.82	5.01
65.00	3.00	4.62	15.79	1.23	-0.92	5.25
66.00	3.00	4.55	16.08	1.15	-1.00	5.46
67.00	3.00	4.48	15.94	1.28	-0.87	5.46
68.00	3.00	4.41	15.98	1.33	-0.82	5.54
69.00	3.00	4.35	16.31	1.23	-0.92	5.77

Hochleistungs-Breitband Balun / Halter VHBD 9134 + BBAL 9136 Elemente
High Power Broadband Balun / Holder VHBD 9134 + BBAL 9136 Elements

Frequency	Distance	Wavelength	Attenuation	Gain(Isotr.)	Gain(Dipole)	Ant.-Factor
MHz	m	m	dB	dBi	dBd	dB/m
70.00	3.00	4.29	16.73	1.08	-1.07	6.04
71.00	3.00	4.23	16.67	1.17	-0.98	6.07
72.00	3.00	4.17	16.89	1.12	-1.03	6.25
73.00	3.00	4.11	17.05	1.10	-1.05	6.38
74.00	3.00	4.05	17.41	0.98	-1.17	6.63
75.00	3.00	4.00	17.46	1.01	-1.14	6.71
76.00	3.00	3.95	17.58	1.01	-1.14	6.82
77.00	3.00	3.90	17.81	0.95	-1.20	7.00
78.00	3.00	3.85	18.07	0.88	-1.27	7.18
79.00	3.00	3.80	18.52	0.71	-1.44	7.46
80.00	3.00	3.75	18.86	0.59	-1.56	7.69
81.00	3.00	3.70	19.16	0.50	-1.65	7.89
82.00	3.00	3.66	19.47	0.40	-1.75	8.10
83.00	3.00	3.61	19.73	0.32	-1.83	8.28
84.00	3.00	3.57	19.68	0.40	-1.75	8.31
85.00	3.00	3.53	19.91	0.33	-1.82	8.48
86.00	3.00	3.49	19.90	0.39	-1.76	8.52
87.00	3.00	3.45	19.59	0.59	-1.56	8.42
88.00	3.00	3.41	19.64	0.62	-1.53	8.49
89.00	3.00	3.37	19.87	0.55	-1.60	8.65
90.00	3.00	3.33	19.85	0.61	-1.54	8.69
91.00	3.00	3.30	19.73	0.72	-1.43	8.68
92.00	3.00	3.26	19.87	0.70	-1.46	8.80
93.00	3.00	3.23	19.98	0.69	-1.46	8.90
94.00	3.00	3.19	20.07	0.69	-1.46	8.99
95.00	3.00	3.16	19.95	0.79	-1.36	8.98
96.00	3.00	3.12	20.25	0.69	-1.46	9.18
97.00	3.00	3.09	20.21	0.75	-1.40	9.20
98.00	3.00	3.06	20.40	0.71	-1.44	9.34
99.00	3.00	3.03	20.58	0.66	-1.49	9.47
100.00	3.00	3.00	20.61	0.69	-1.46	9.53
105.00	3.00	2.86	20.55	0.93	-1.22	9.71
110.00	3.00	2.73	20.61	1.10	-1.05	9.95
115.00	3.00	2.61	20.05	1.58	-0.57	9.86
120.00	3.00	2.50	19.97	1.80	-0.35	10.01
125.00	3.00	2.40	19.80	2.06	-0.09	10.10
130.00	3.00	2.31	20.38	1.94	-0.21	10.56
135.00	3.00	2.22	21.47	1.56	-0.59	11.26
140.00	3.00	2.14	22.38	1.26	-0.89	11.88
145.00	3.00	2.07	23.21	1.00	-1.15	12.44
150.00	3.00	2.00	24.80	0.35	-1.80	13.39
155.00	3.00	1.94	24.99	0.40	-1.75	13.62
160.00	3.00	1.87	25.46	0.30	-1.85	14.00
165.00	3.00	1.82	26.33	0.00	-2.15	14.57
170.00	3.00	1.76	27.07	-0.23	-2.39	15.06
175.00	3.00	1.71	28.11	-0.63	-2.78	15.71
180.00	3.00	1.67	28.84	-0.88	-3.03	16.20
185.00	3.00	1.62	28.71	-0.69	-2.84	16.25
190.00	3.00	1.58	28.99	-0.71	-2.86	16.51
195.00	3.00	1.54	29.47	-0.84	-2.99	16.86
200.00	3.00	1.50	31.59	-1.79	-3.94	18.03



Hochleistungs-Breitband Balun / Halter VHBD 9134 + BBAL 9136 Elemente
High Power Broadband Balun / Holder VHBD 9134 + BBAL 9136 Elements

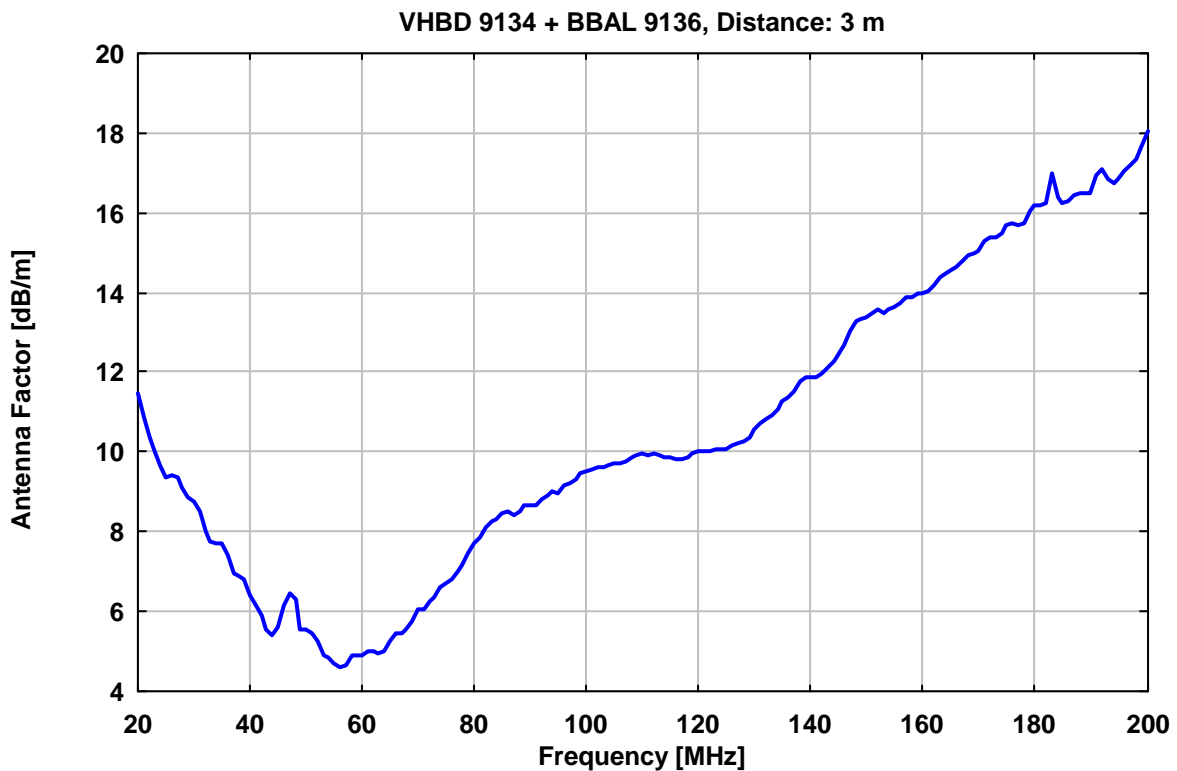
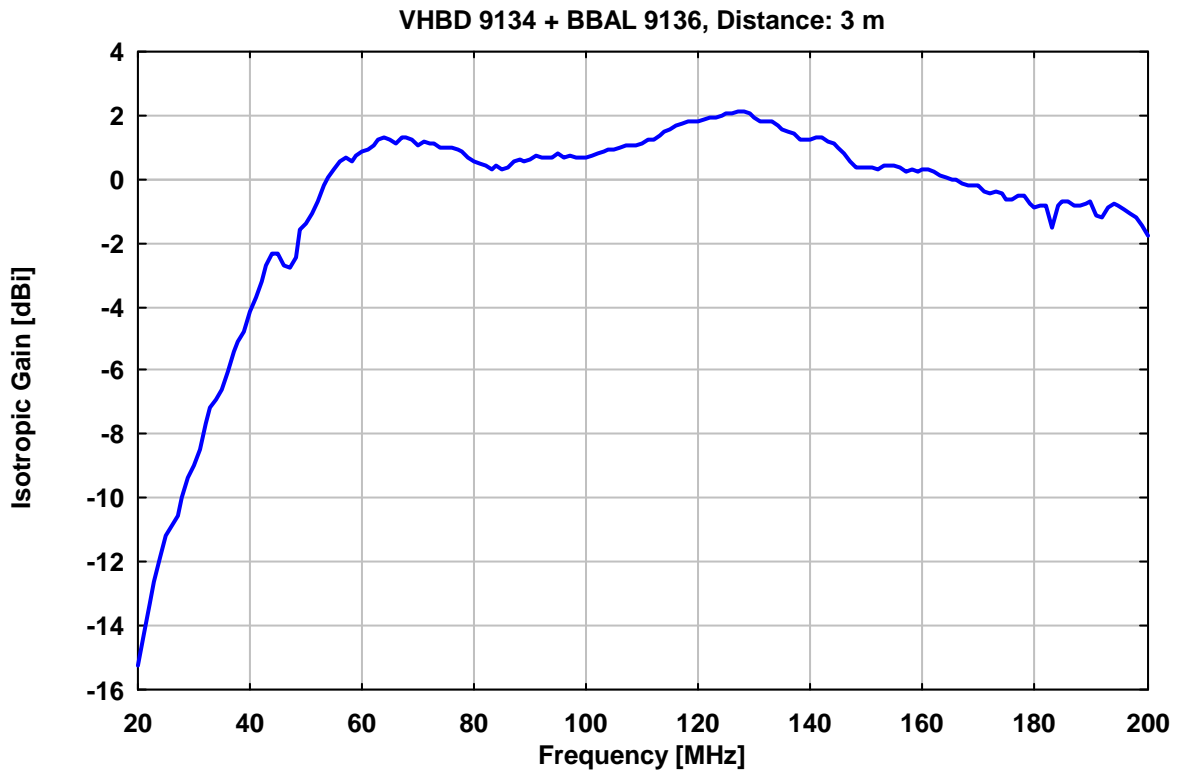

Hochleistungs-Breitband Balun / Halter VHBD 9134 + BBAL 9136 Elemente
High Power Broadband Balun / Holder VHBD 9134 + BBAL 9136 Elements

Frequency	Distance	Wavelength	Attenuation	Gain(Isotr.)	Gain(Dipole)	Ant.-Factor
MHz	m	m	dB	dBi	dBd	dB/m
20.00	5.00	15.00	43.45	-15.51	-17.66	11.75
21.00	5.00	14.29	42.14	-14.64	-16.79	11.30
22.00	5.00	13.64	40.30	-13.51	-15.67	10.58
23.00	5.00	13.04	38.62	-12.48	-14.63	9.94
24.00	5.00	12.50	37.42	-11.70	-13.85	9.52
25.00	5.00	12.00	36.52	-11.07	-13.22	9.25
26.00	5.00	11.54	35.85	-10.57	-12.72	9.09
27.00	5.00	11.11	35.32	-10.14	-12.29	8.98
28.00	5.00	10.71	34.91	-9.77	-11.92	8.93
29.00	5.00	10.34	34.61	-9.47	-11.62	8.94
30.00	5.00	10.00	34.32	-9.18	-11.33	8.94
31.00	5.00	9.68	33.60	-8.67	-10.82	8.72
32.00	5.00	9.38	32.67	-8.07	-10.22	8.40
33.00	5.00	9.09	31.76	-7.48	-9.63	8.07
34.00	5.00	8.82	31.05	-7.00	-9.15	7.85
35.00	5.00	8.57	30.28	-6.49	-8.64	7.59
36.00	5.00	8.33	29.44	-5.95	-8.10	7.29
37.00	5.00	8.11	28.63	-5.42	-7.57	7.01
38.00	5.00	7.89	28.06	-5.02	-7.17	6.84
39.00	5.00	7.69	27.39	-4.57	-6.72	6.61
40.00	5.00	7.50	26.63	-4.08	-6.23	6.35
41.00	5.00	7.32	25.74	-3.53	-5.68	6.00
42.00	5.00	7.14	24.75	-2.93	-5.08	5.62
43.00	5.00	6.98	23.69	-2.30	-4.45	5.19
44.00	5.00	6.82	22.97	-1.84	-3.99	4.93
45.00	5.00	6.67	23.22	-1.87	-4.02	5.15
46.00	5.00	6.52	24.14	-2.23	-4.38	5.71
47.00	5.00	6.38	24.65	-2.39	-4.55	6.06
48.00	5.00	6.25	24.23	-2.09	-4.24	5.94
49.00	5.00	6.12	23.84	-1.81	-3.96	5.83
50.00	5.00	6.00	23.31	-1.45	-3.60	5.65
51.00	5.00	5.88	22.21	-0.82	-2.97	5.19
52.00	5.00	5.77	20.80	-0.03	-2.18	4.57
53.00	5.00	5.66	19.89	0.51	-1.64	4.19
54.00	5.00	5.56	19.57	0.75	-1.40	4.12
55.00	5.00	5.45	19.30	0.96	-1.19	4.06
56.00	5.00	5.36	19.11	1.14	-1.01	4.05
57.00	5.00	5.26	18.98	1.28	-0.87	4.06
58.00	5.00	5.17	19.14	1.28	-0.88	4.21
59.00	5.00	5.08	19.40	1.22	-0.93	4.42
60.00	5.00	5.00	19.73	1.13	-1.02	4.65
61.00	5.00	4.92	20.00	1.06	-1.09	4.86
62.00	5.00	4.84	20.12	1.08	-1.07	4.99
63.00	5.00	4.76	20.24	1.09	-1.06	5.12
64.00	5.00	4.69	20.29	1.13	-1.02	5.21
65.00	5.00	4.62	20.40	1.14	-1.01	5.34
66.00	5.00	4.55	20.42	1.20	-0.95	5.41
67.00	5.00	4.48	20.48	1.23	-0.92	5.51
68.00	5.00	4.41	20.56	1.25	-0.90	5.62
69.00	5.00	4.35	20.60	1.30	-0.85	5.70

Hochleistungs-Breitband Balun / Halter VHBD 9134 + BBAL 9136 Elemente
High Power Broadband Balun / Holder VHBD 9134 + BBAL 9136 Elements

Frequency	Distance	Wavelength	Attenuation	Gain(Isotr.)	Gain(Dipole)	Ant.-Factor
MHz	m	m	dB	dBi	dBd	dB/m
70.00	5.00	4.29	20.70	1.31	-0.84	5.81
71.00	5.00	4.23	20.73	1.36	-0.79	5.89
72.00	5.00	4.17	20.91	1.33	-0.82	6.04
73.00	5.00	4.11	20.90	1.39	-0.76	6.09
74.00	5.00	4.05	21.03	1.39	-0.76	6.22
75.00	5.00	4.00	21.16	1.38	-0.77	6.34
76.00	5.00	3.95	21.47	1.28	-0.87	6.55
77.00	5.00	3.90	21.66	1.24	-0.91	6.71
78.00	5.00	3.85	21.67	1.29	-0.86	6.77
79.00	5.00	3.80	21.68	1.35	-0.80	6.82
80.00	5.00	3.75	21.78	1.35	-0.80	6.93
81.00	5.00	3.70	22.04	1.28	-0.87	7.11
82.00	5.00	3.66	22.20	1.25	-0.90	7.25
83.00	5.00	3.61	22.45	1.18	-0.97	7.42
84.00	5.00	3.57	22.76	1.08	-1.08	7.63
85.00	5.00	3.53	23.12	0.94	-1.21	7.86
86.00	5.00	3.49	23.39	0.86	-1.29	8.05
87.00	5.00	3.45	23.69	0.76	-1.39	8.25
88.00	5.00	3.41	24.09	0.61	-1.54	8.50
89.00	5.00	3.37	24.42	0.49	-1.66	8.71
90.00	5.00	3.33	24.66	0.43	-1.73	8.88
91.00	5.00	3.30	24.69	0.46	-1.69	8.94
92.00	5.00	3.26	24.75	0.47	-1.68	9.02
93.00	5.00	3.23	24.73	0.53	-1.62	9.06
94.00	5.00	3.19	24.83	0.53	-1.62	9.16
95.00	5.00	3.16	24.81	0.58	-1.57	9.19
96.00	5.00	3.12	24.89	0.59	-1.56	9.28
97.00	5.00	3.09	24.88	0.64	-1.51	9.31
98.00	5.00	3.06	24.86	0.69	-1.46	9.35
99.00	5.00	3.03	24.74	0.80	-1.35	9.33
100.00	5.00	3.00	24.57	0.93	-1.23	9.29
105.00	5.00	2.86	24.07	1.39	-0.76	9.26
110.00	5.00	2.73	23.78	1.74	-0.41	9.31
115.00	5.00	2.61	24.04	1.80	-0.35	9.64
120.00	5.00	2.50	24.39	1.81	-0.34	9.99
125.00	5.00	2.40	24.04	2.16	0.01	10.00
130.00	5.00	2.31	24.50	2.10	-0.05	10.40
135.00	5.00	2.22	25.10	1.96	-0.19	10.86
140.00	5.00	2.14	25.57	1.89	-0.26	11.25
145.00	5.00	2.07	27.03	1.31	-0.84	12.14
150.00	5.00	2.00	28.33	0.81	-1.34	12.93
155.00	5.00	1.94	28.55	0.84	-1.31	13.19
160.00	5.00	1.87	29.38	0.56	-1.59	13.74
165.00	5.00	1.82	29.88	0.44	-1.71	14.13
170.00	5.00	1.76	30.51	0.26	-1.89	14.57
175.00	5.00	1.71	31.35	-0.03	-2.18	15.11
180.00	5.00	1.67	31.36	0.09	-2.06	15.24
185.00	5.00	1.62	31.91	-0.07	-2.22	15.63
190.00	5.00	1.58	33.42	-0.71	-2.86	16.51
195.00	5.00	1.54	33.26	-0.52	-2.67	16.54
200.00	5.00	1.50	35.31	-1.44	-3.59	17.68



Hochleistungs-Breitband Balun / Halter VHBD 9134 + BBAL 9136 Elemente
High Power Broadband Balun / Holder VHBD 9134 + BBAL 9136 Elements

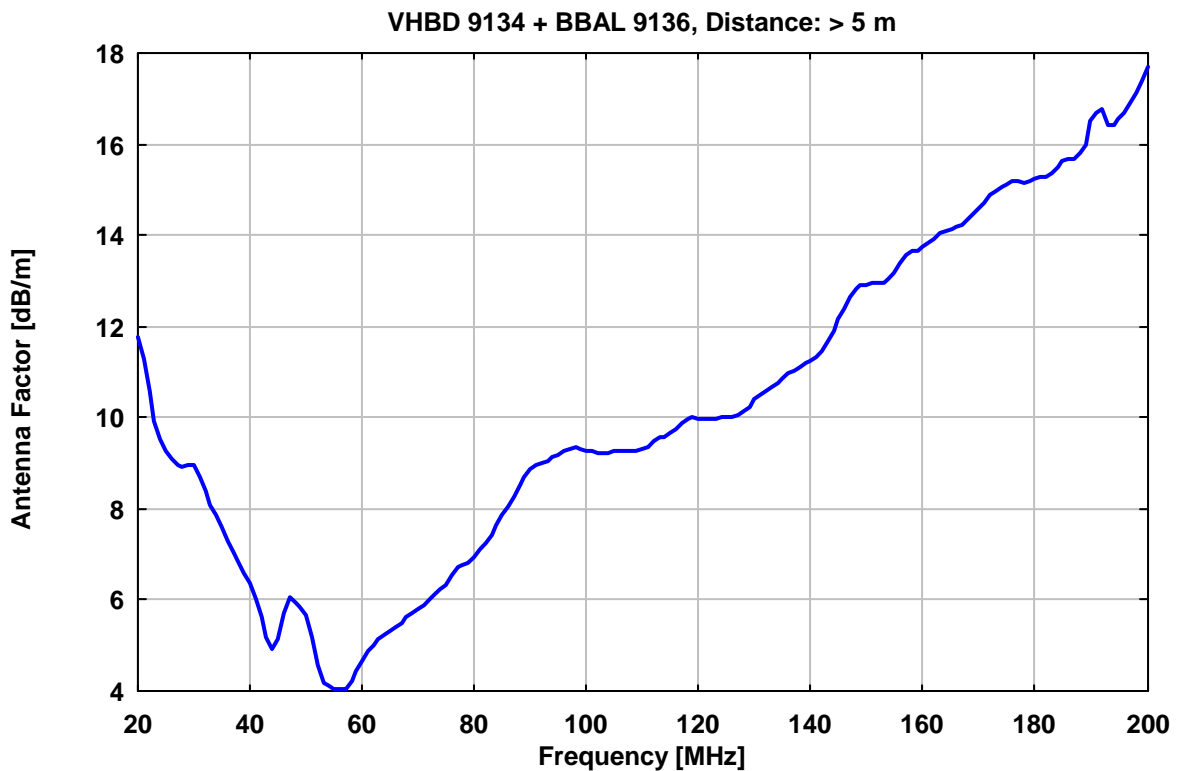
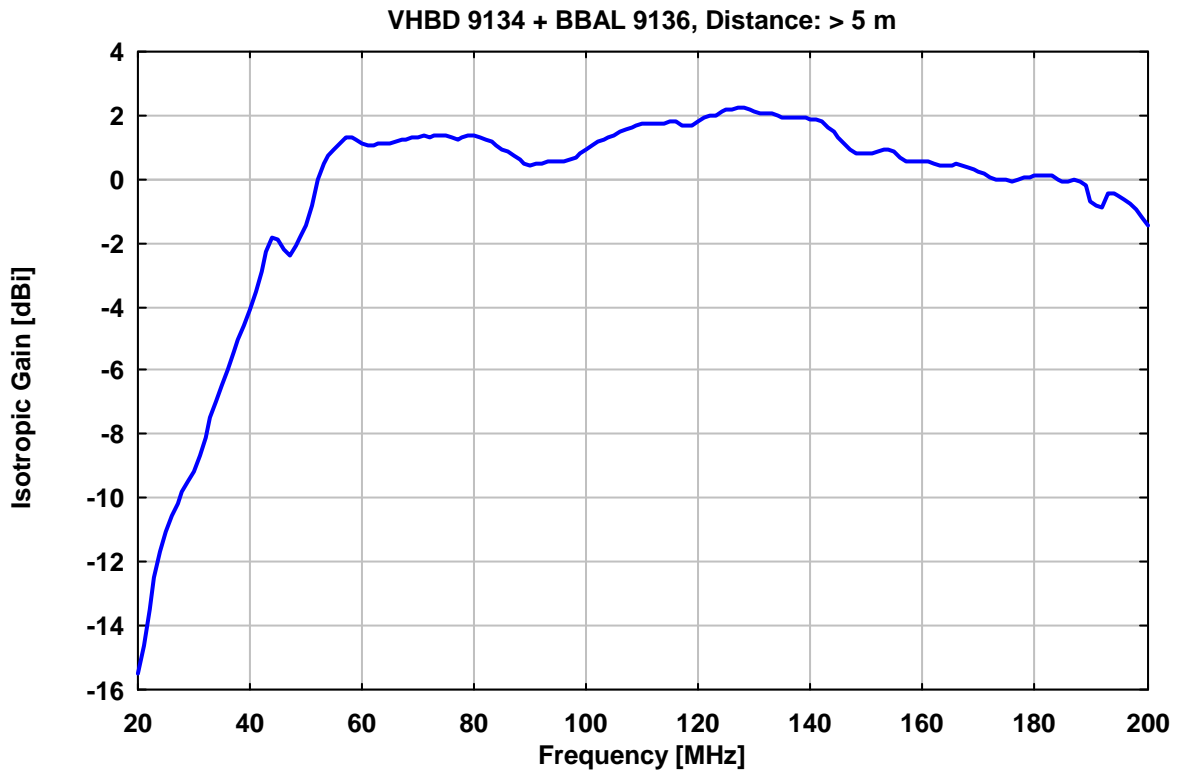



Hochleistungs-Breitband Balun / Halter VHBD 9134 + BBAL 9136 Elemente
High Power Broadband Balun / Holder VHBD 9134 + BBAL 9136 Elements

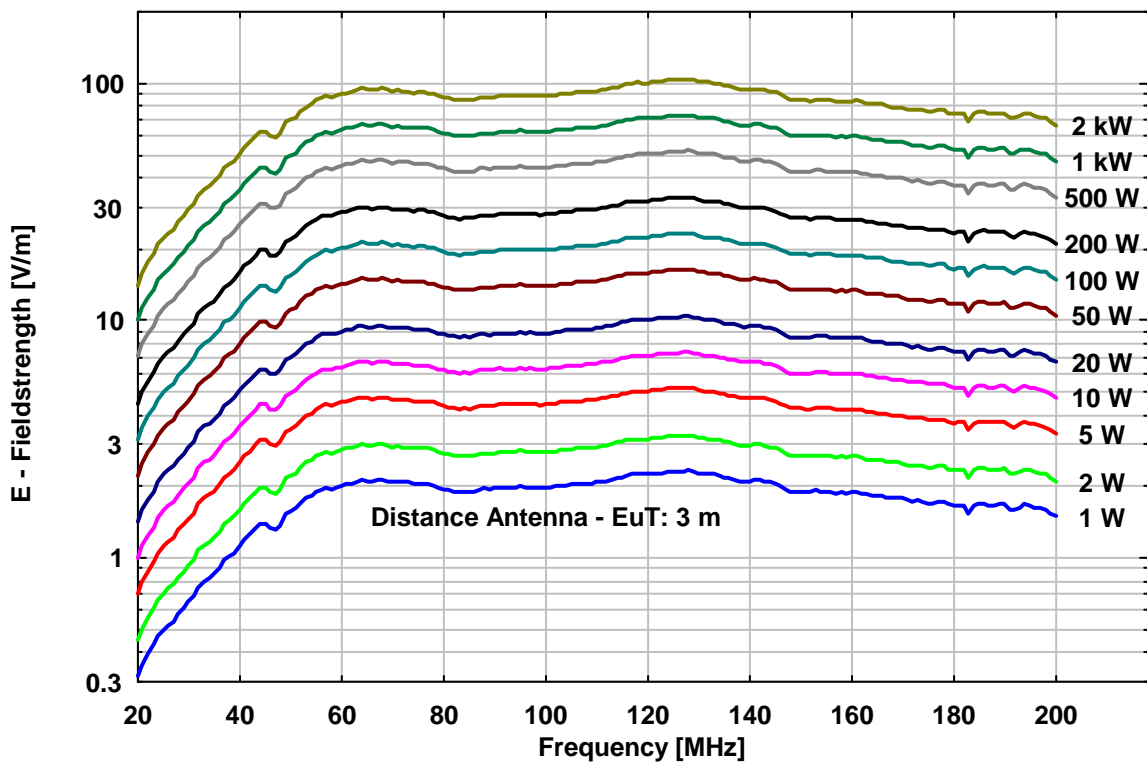
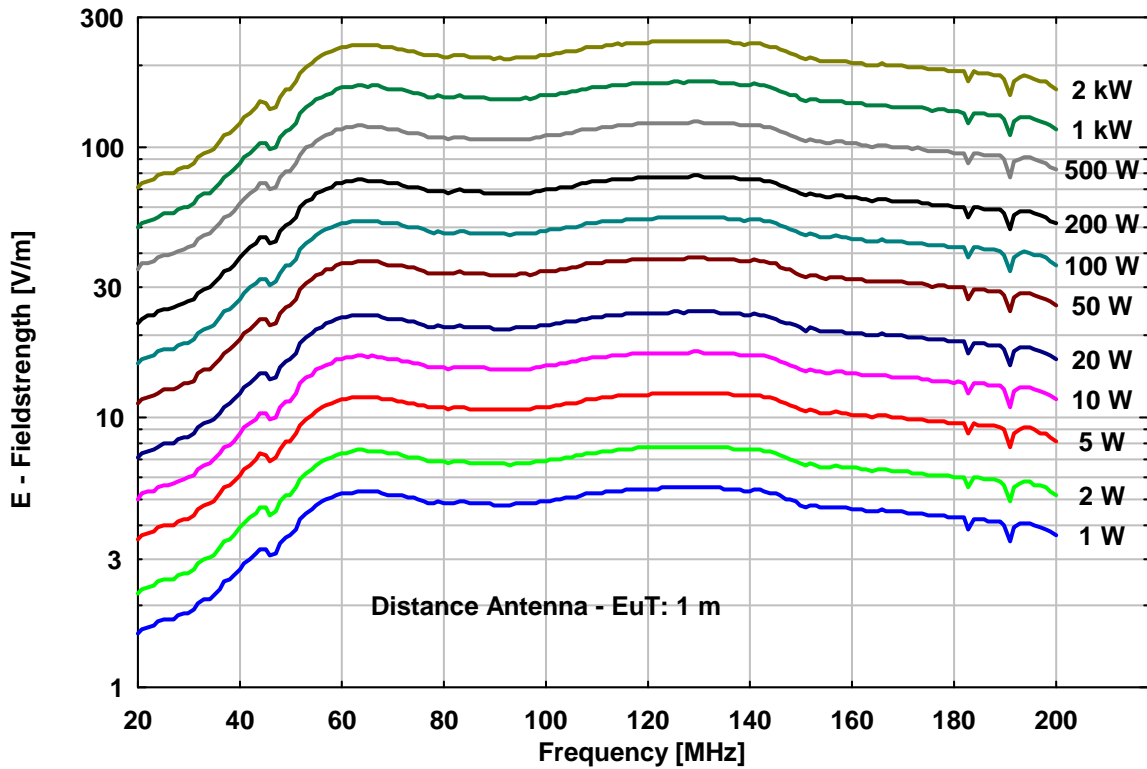

Hochleistungs-Breitband Balun / Halter VHBD 9134 + BBFA 9146 Elemente
High Power Broadband Balun / Holder VHBD 9134 + BBFA 9146 Elements

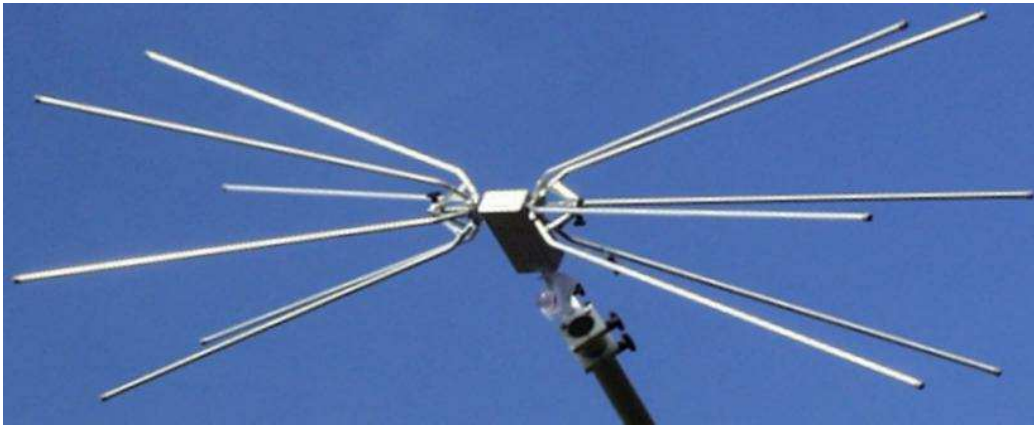

VHBD 9134 Balun mit BBFA 9146 Faltkonus-Elementen (ohne Verlängerungen)
VHBD 9134 Balun with BBFA 9146 Collapsible Elements (no extensions mounted)

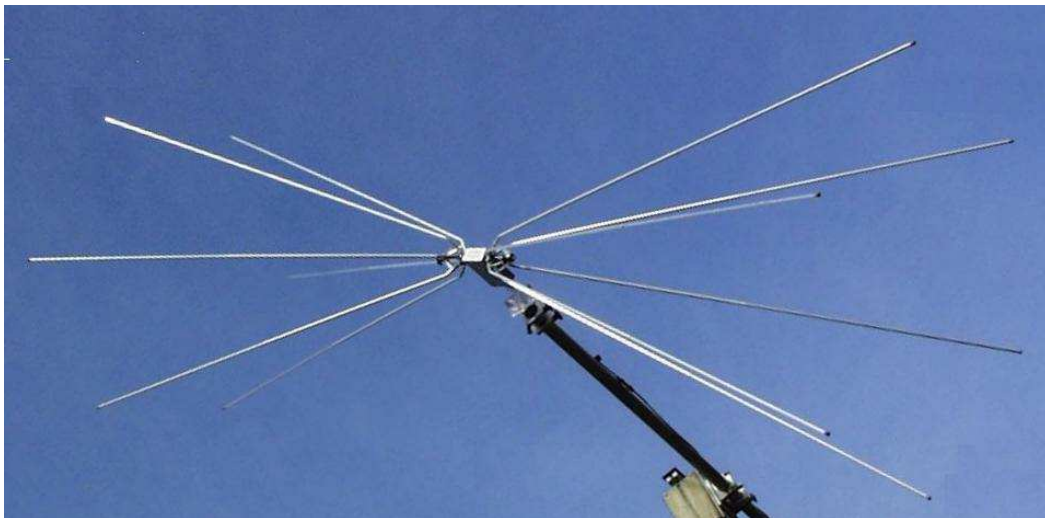

VHBD 9134 Balun mit BBFA 9146 Faltkonus-Elementen (mit Verlängerungen)
VHBD 9134 Balun with BBFA 9146 Collapsible Elements (extensions mounted)

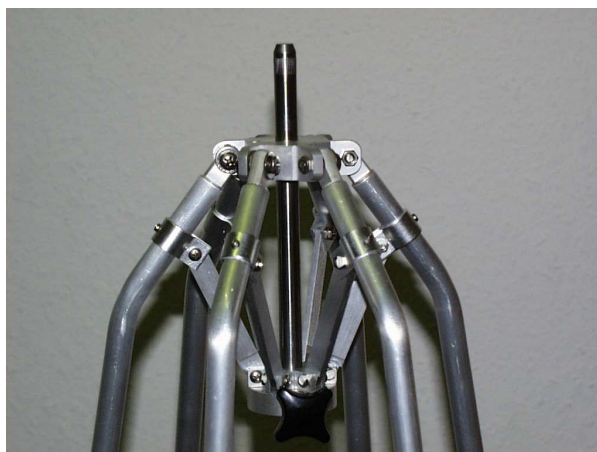

BBFA 9146 Faltkonus-Element mit Feststellschraube
BBFA 9146 Collapsible Elements with fixing screw

Hochleistungs-Breitband Balun / Halter VHBD 9134 + BBFA 9146 Elemente
High Power Broadband Balun / Holder VHBD 9134 + BBFA 9146 Elements

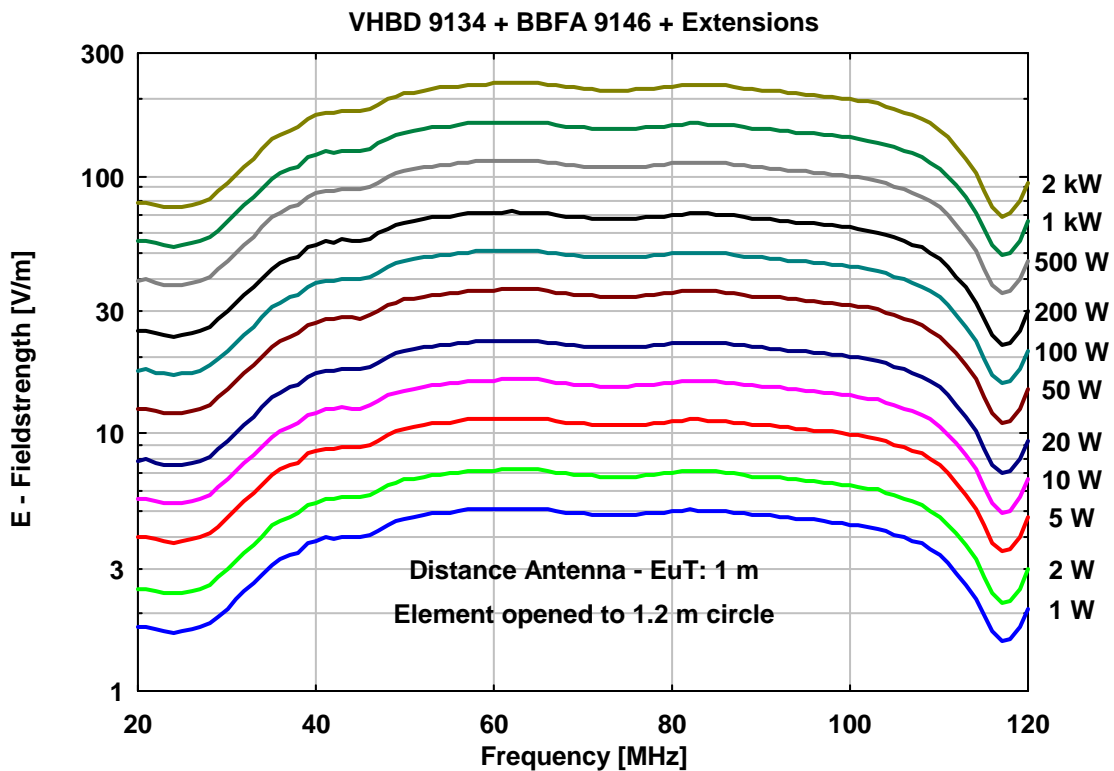
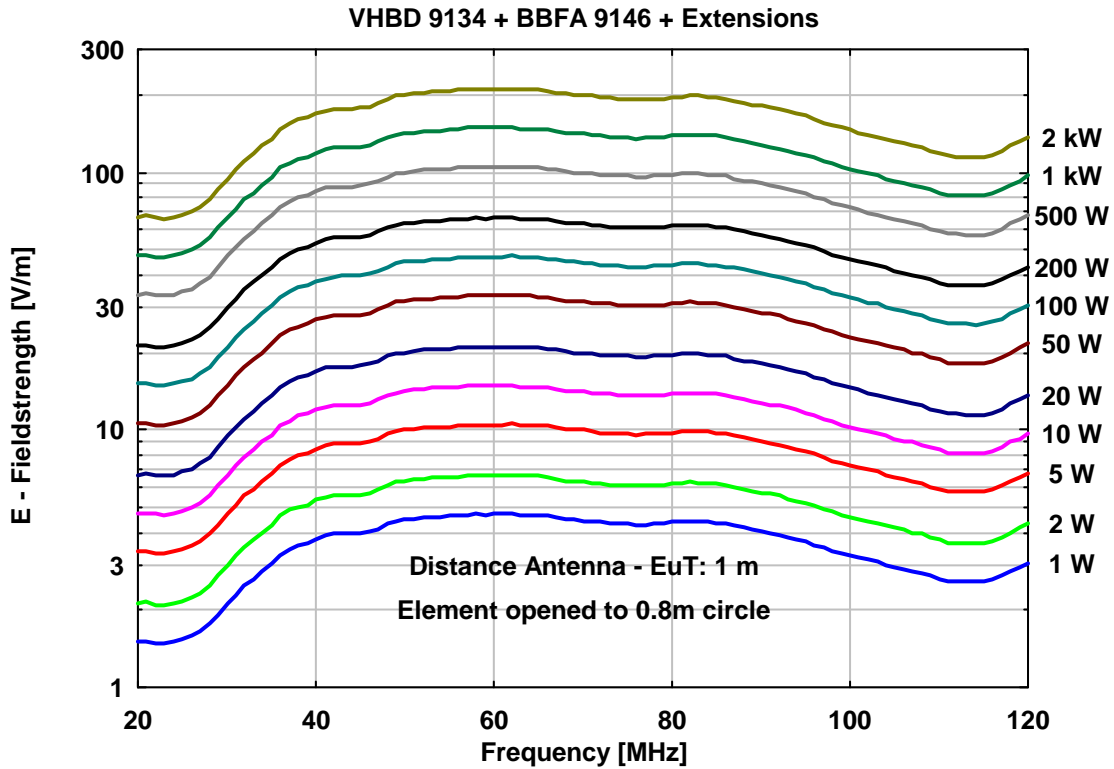



Hochleistungs-Breitband Balun / Halter VHBD 9134 + BBFA 9146 Elemente
High Power Broadband Balun / Holder VHBD 9134 + BBFA 9146 Elements

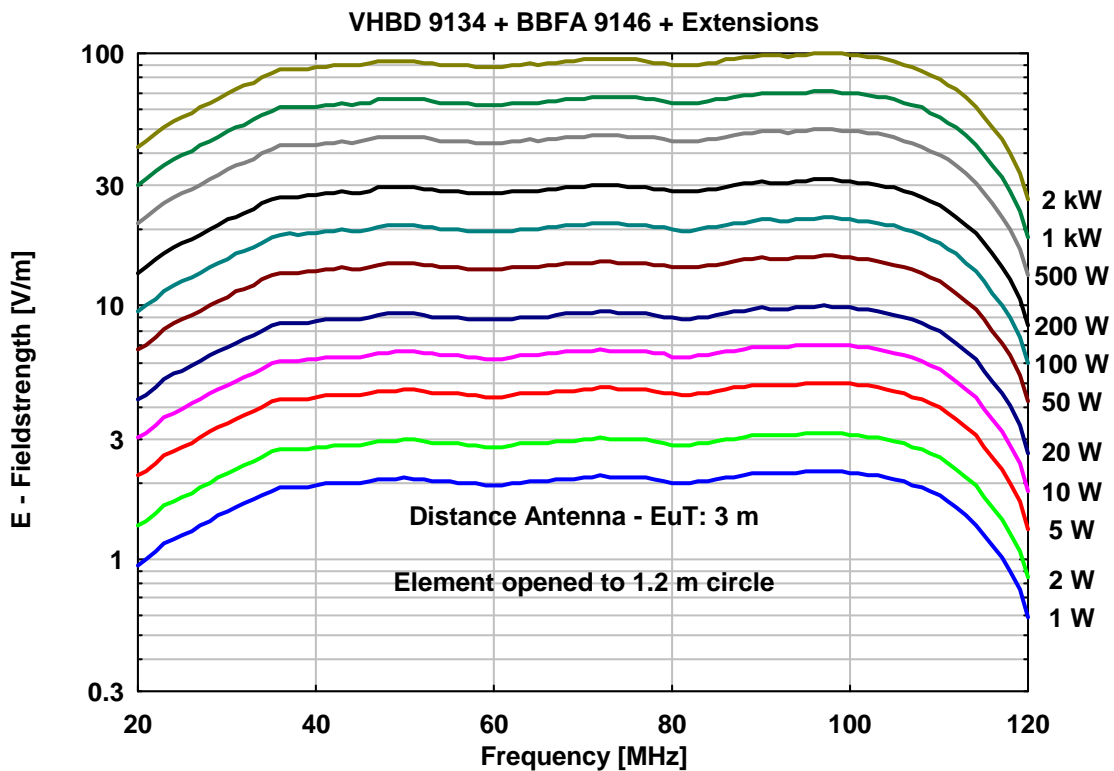
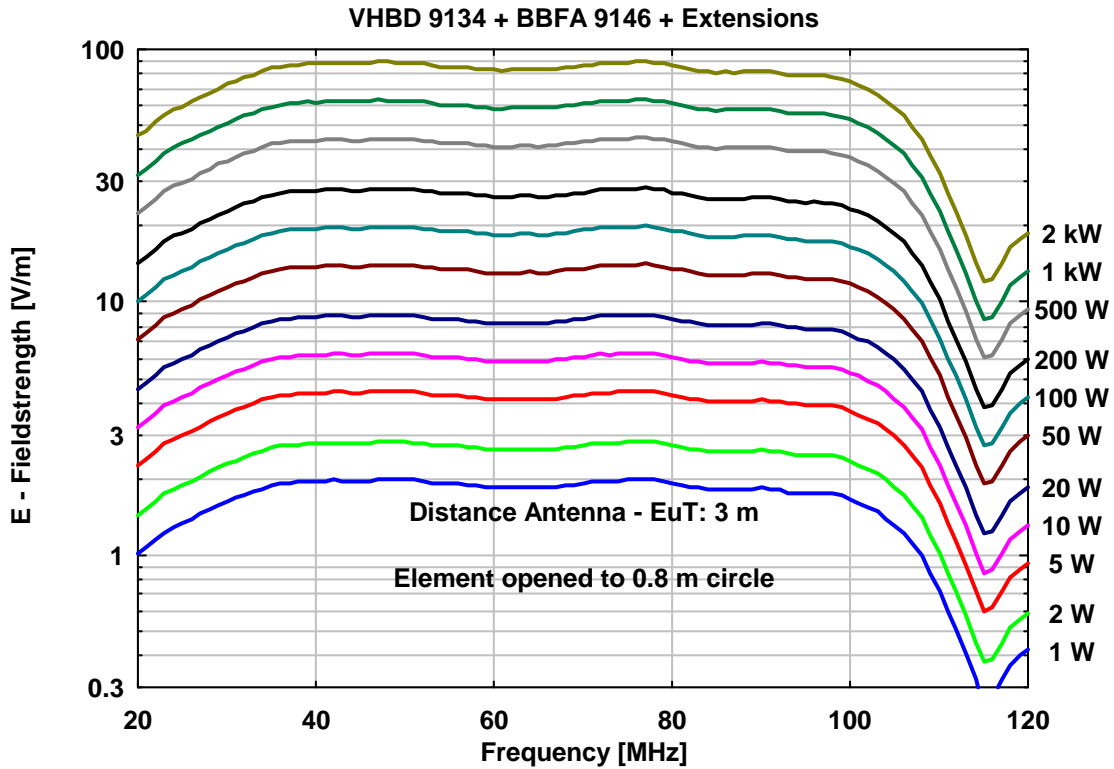

Hochleistungs-Breitband Balun / Halter VHBD 9134 + BBFA 9146 Elemente
High Power Broadband Balun / Holder VHBD 9134 + BBFA 9146 Elements

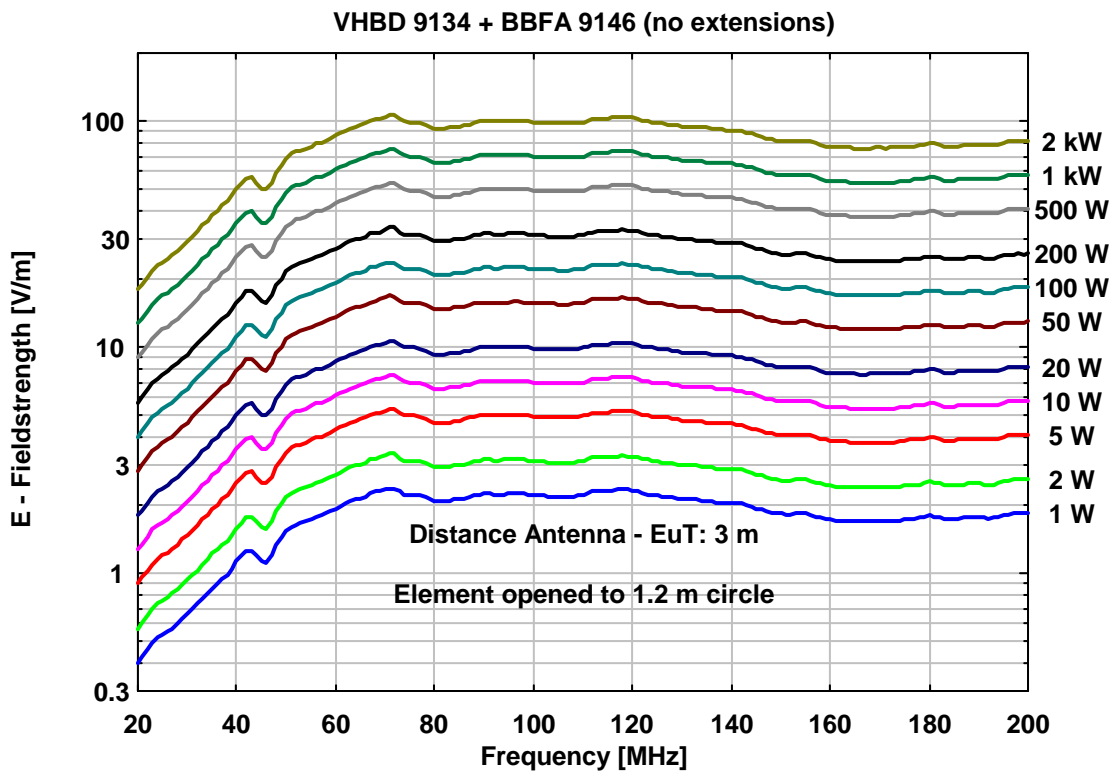
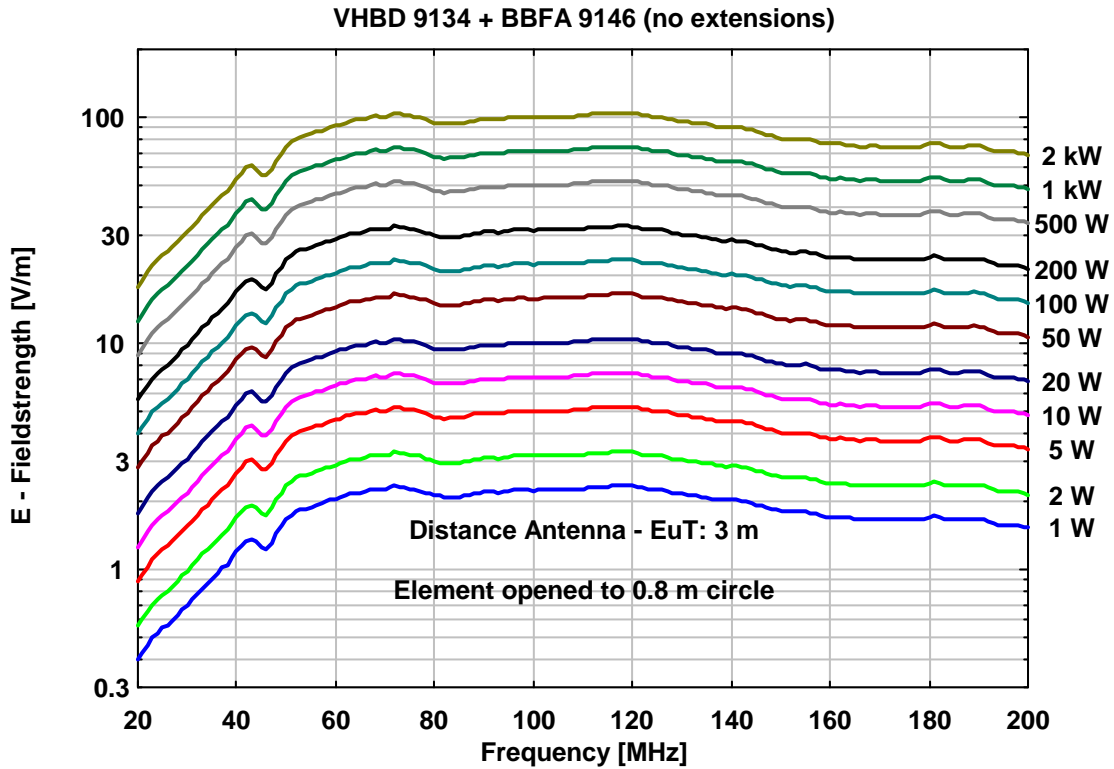

Hochleistungs-Breitband Balun / Halter VHBD 9134 + BBFA 9146 Elemente
High Power Broadband Balun / Holder VHBD 9134 + BBFA 9146 Elements

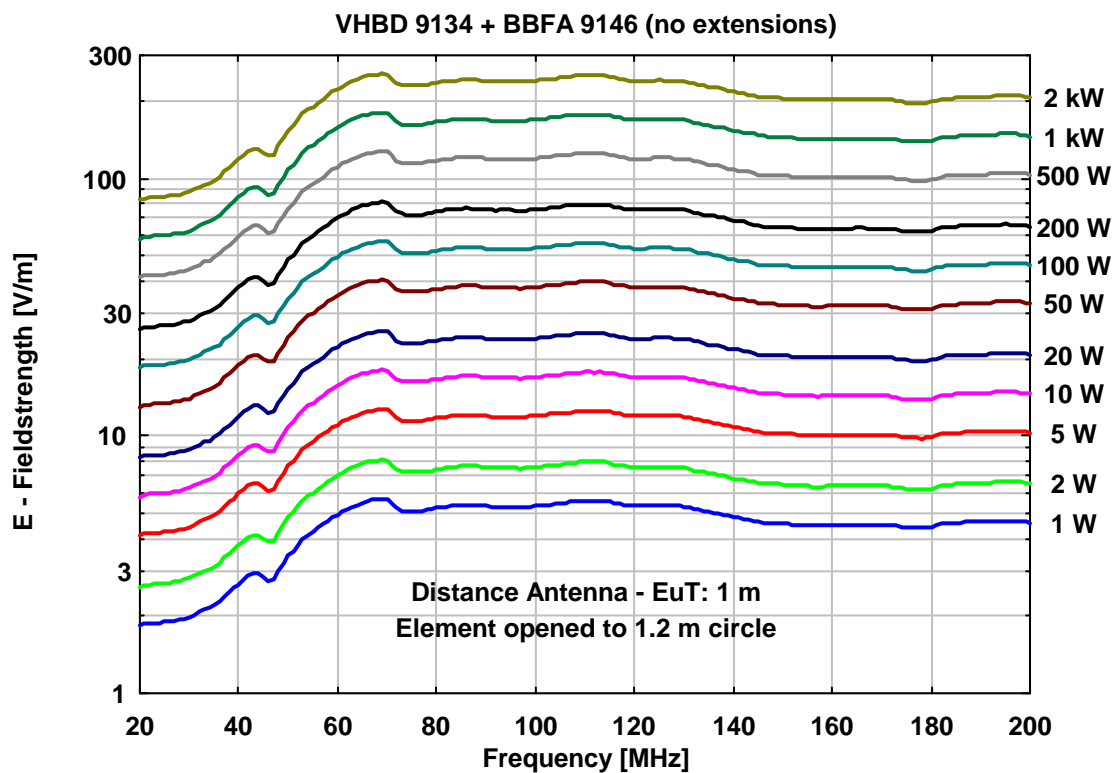
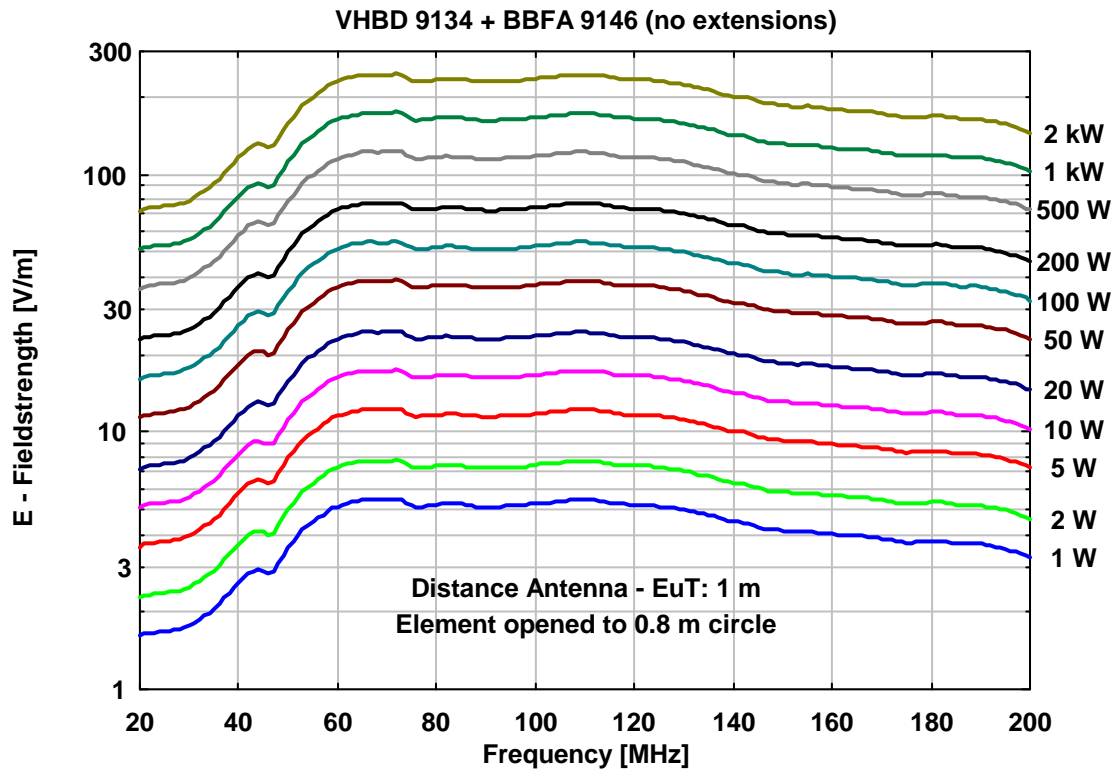

Hochleistungs-Breitband Balun / Halter VHBD 9134 + BBFA 9146 Elemente
High Power Broadband Balun / Holder VHBD 9134 + BBFA 9146 Elements

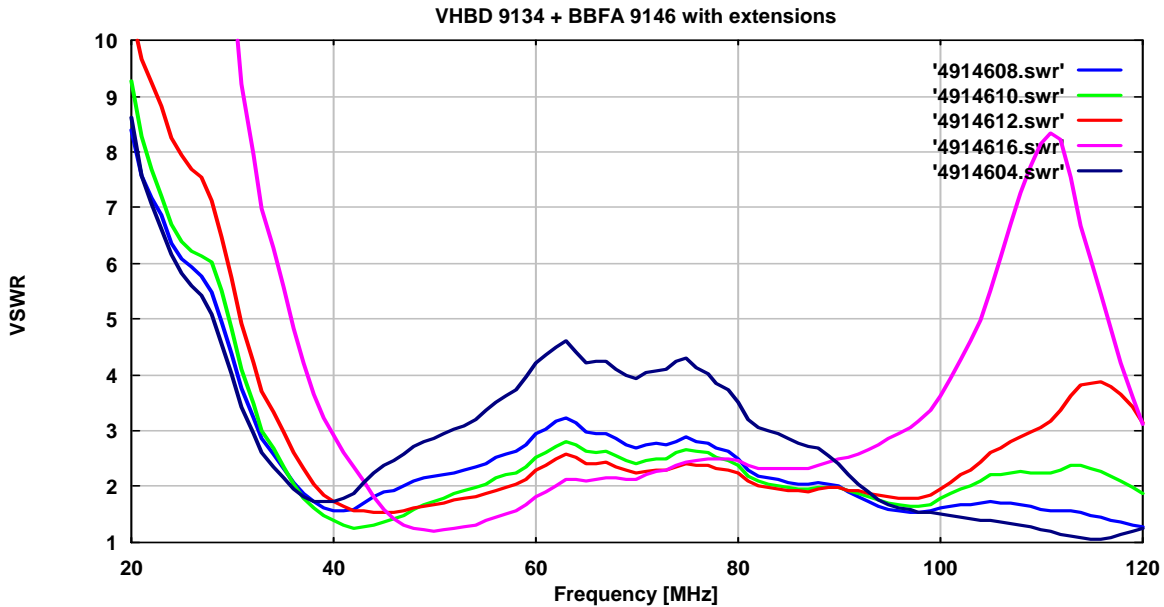

VHBD 9134 with BBFA 9146 with Extensions opened to diameters of 0.4 m to 1.6 m measured at the element junction.

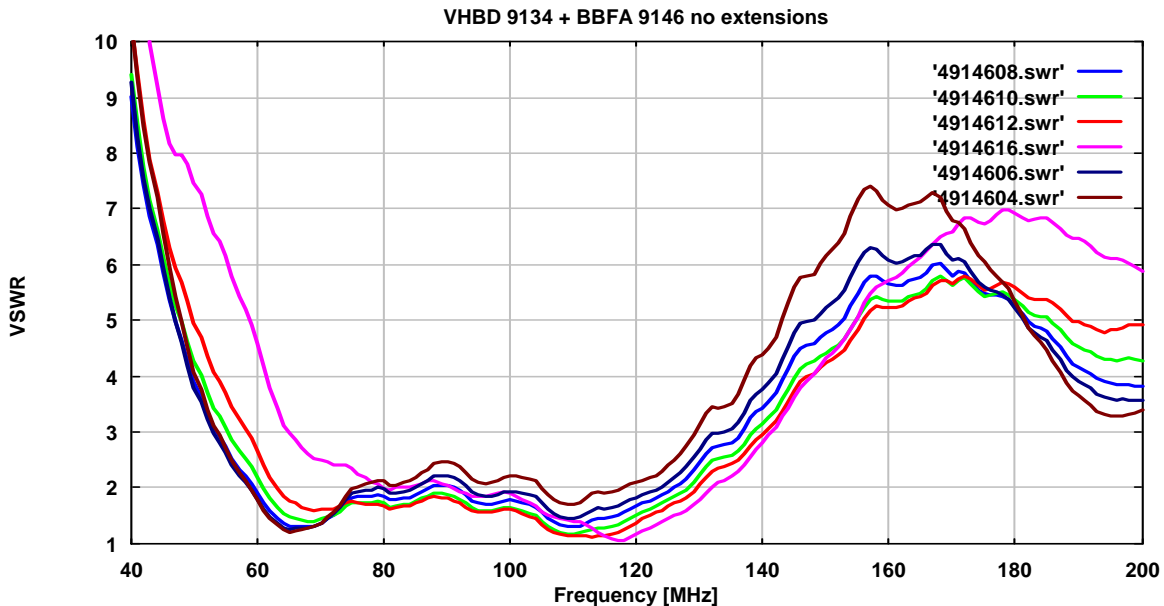

VHBD 9134 with BBFA 9146 without Extensions opened to diameters of 0.4 m to 1.6 m measured at the element junction.