

# SCHWARZBECK MESS - ELEKTRONIK

An der Klinge 29 D-69250 Schönau Tel.: 06228/1001 Fax.: (49)6228/1003

## Mikrowellen Bikonus-Breitband-Antenne SBA 9112 Microwave Biconical Broadband Antenna SBA 9112

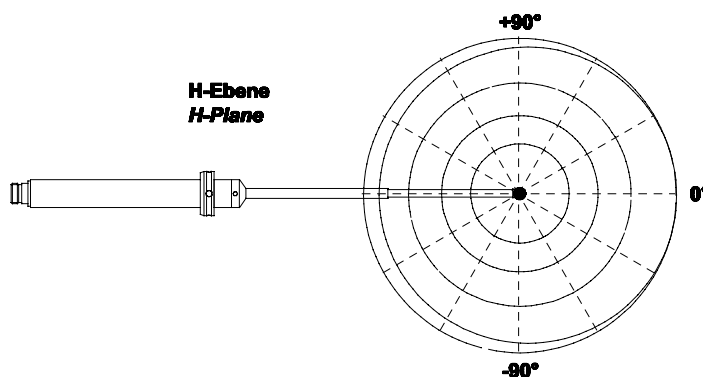

### Anforderungen an das Richtdiagramm gem. CISPR 16-1-4

Im Gegensatz zur allgemein üblichen und bewährten Praxis, auf 0 dB normierte Richtdiagramme zu verwenden, wird in CISPR 16-1-4 für die H-Ebene ein abweichendes Verfahren zur Darstellung der Richtdiagramme verwendet. Bei diesem Verfahren wird der Mittelwert des Richtdiagramms der H-Ebene in einem Winkelbereich von  $-135^\circ$  bis  $+135^\circ$  bestimmt, der dann letztlich als 0 dB-Bezugswert dient. Beim Auftragen der Richtcharakteristik erhält man dadurch sowohl positive als auch negative Werte. Die Richtcharakteristik darf die grau markierten Flächen nicht schneiden (sog. verbotene Bereiche). Dabei müssen zwei verschiedene Toleranzfelder beachtet werden, eines von 1-6 GHz, das andere von 6-18 GHz.

### Pattern Requirements acc. to CISPR 16-1-4

*In contrast to the common practice to use directional patterns being normalized to unity or 0 dB respectively, CISPR 16-1-4 uses a different method to present the directional patterns of the H-plane. This method is based on averaging the pattern in a range from  $-135^\circ$  to  $+135^\circ$ , the averaged value is finally used as 0 dB reference. Therefore the resulting pattern has both, positive and negative sign. The pattern curve must not intersect the grey marked fields (so called forbidden areas). Two different requirements for the forbidden area have to be considered, one is defined for the frequency range from 1 to 6 GHz, the other is defined from 6 to 18 GHz.*

Angle Range / Winkelbereich	1-6 GHz	6-18 GHz
$-60^\circ \dots +60^\circ$	+/- 2 dB	+/- 3 dB
$-60^\circ \dots -135^\circ, +60^\circ \dots +135^\circ$	+/- 3 dB	+/- 4 dB
$-135^\circ \dots -180^\circ, +135^\circ \dots +180^\circ$	< + 3 dB	< + 4 dB

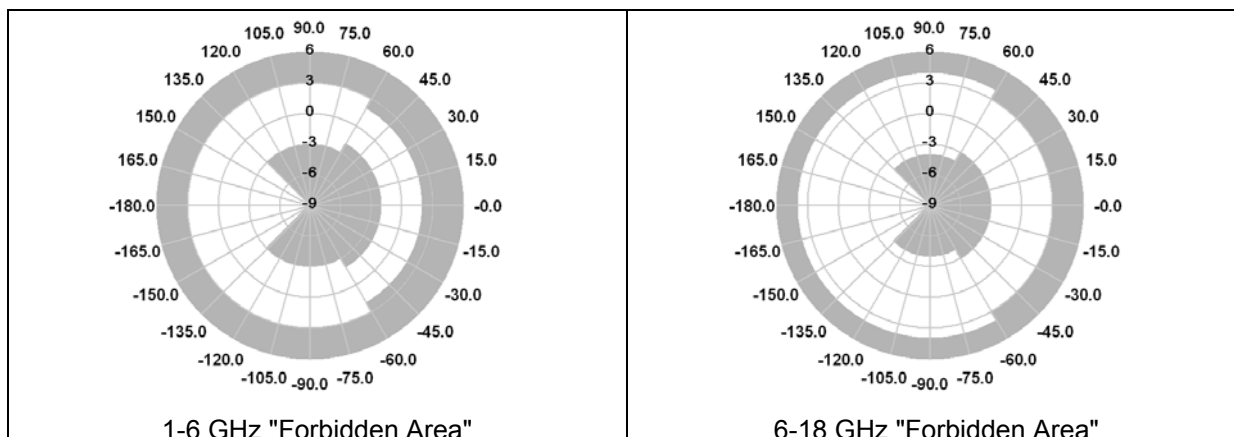

# SCHWARZBECK MESS - ELEKTRONIK

An der Klinge 29 D-69250 Schönau Tel.: 06228/1001 Fax.: (49)6228/1003

## Mikrowellen Bikonus-Breitband-Antenne SBA 9112 *Microwave Biconical Broadband Antenna SBA 9112*

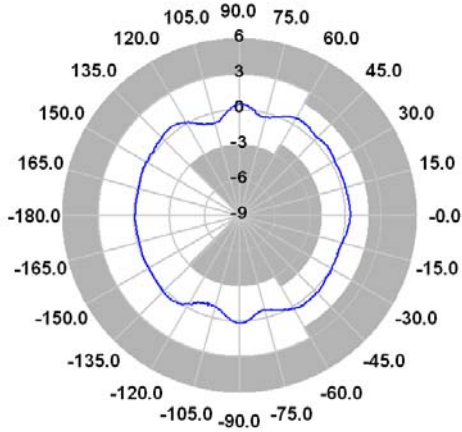

H-Ebene / H-Plane 1 GHz

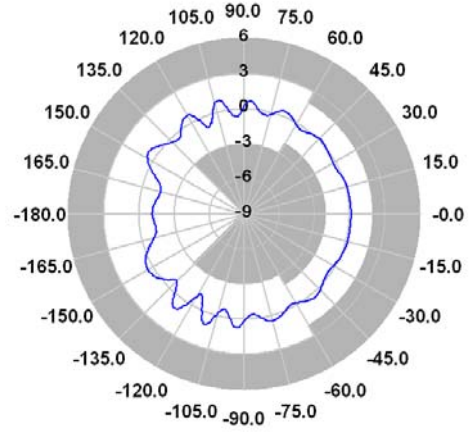

H-Ebene / H-Plane 2 GHz

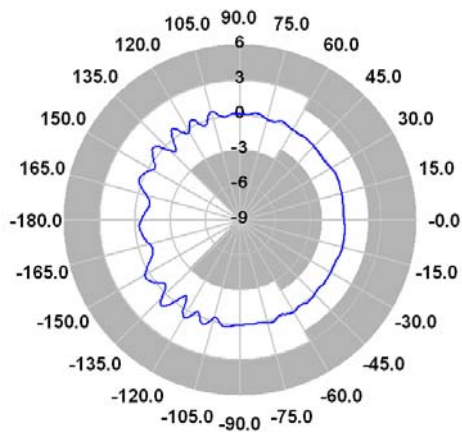

H-Ebene / H-Plane 3 GHz

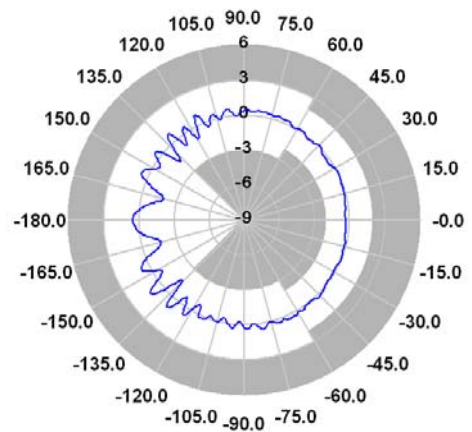

H-Ebene / H-Plane 4 GHz

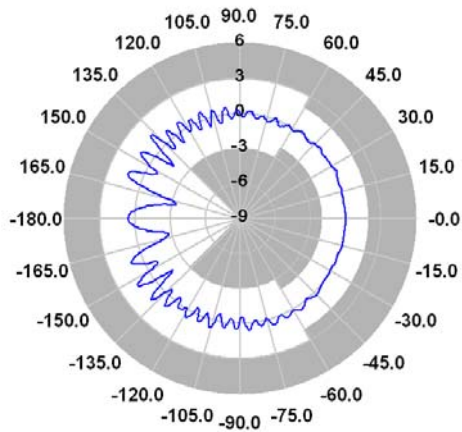

H-Ebene / H-Plane 5 GHz

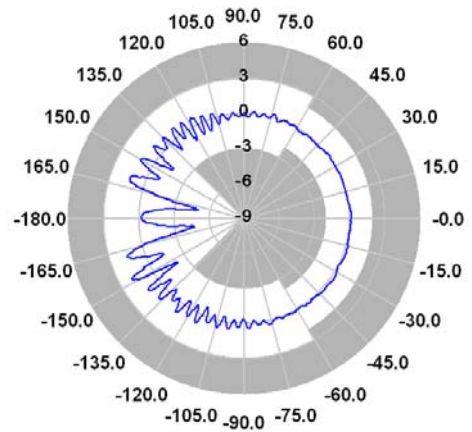

H-Ebene / H-Plane 6 GHz

# SCHWARZBECK MESS - ELEKTRONIK

An der Klinge 29 D-69250 Schönau Tel.: 06228/1001 Fax.: (49)6228/1003

## Mikrowellen Bikonus-Breitband-Antenne SBA 9112 *Microwave Biconical Broadband Antenna SBA 9112*

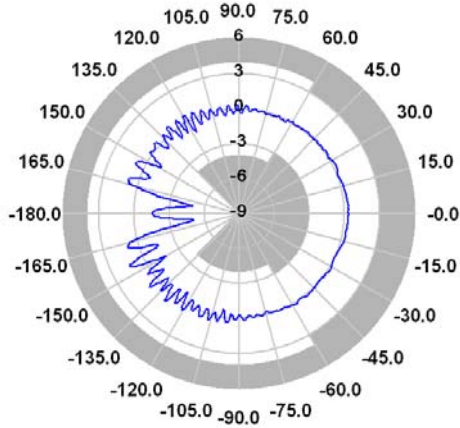

H-Ebene / H-Plane 7 GHz

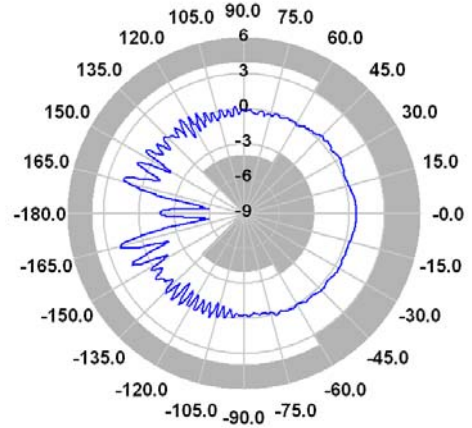

H-Ebene / H-Plane 8 GHz

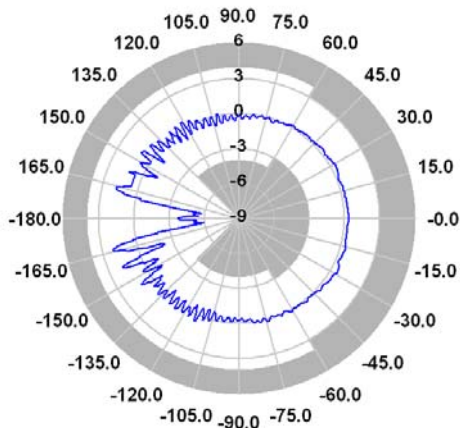

H-Ebene / H-Plane 9 GHz

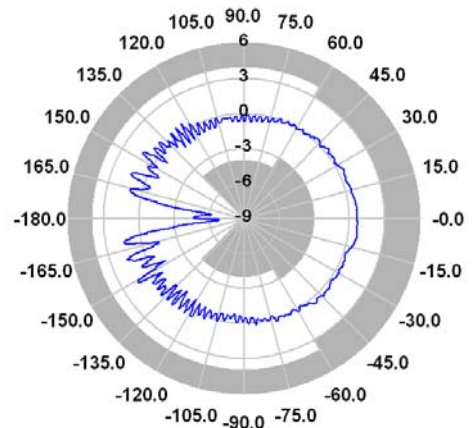

H-Ebene / H-Plane 10 GHz

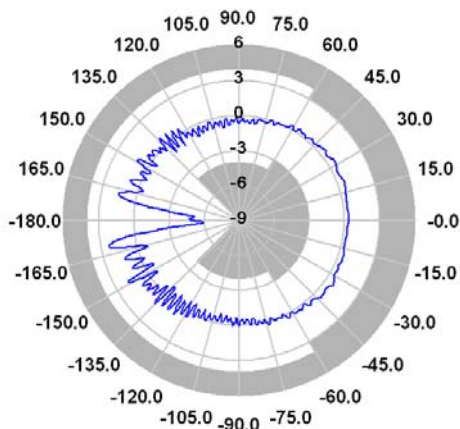

H-Ebene / H-Plane 11 GHz

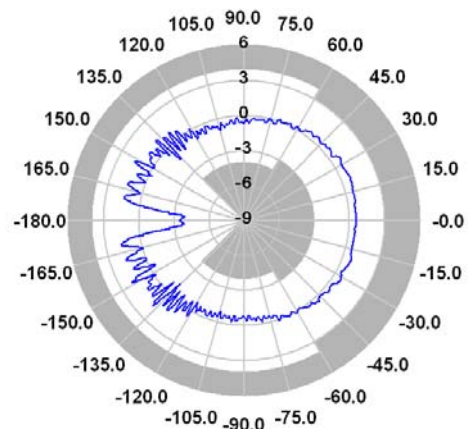

H-Ebene / H-Plane 12 GHz

# SCHWARZBECK MESS - ELEKTRONIK

An der Klinge 29 D-69250 Schönau Tel.: 06228/1001 Fax.: (49)6228/1003

## Mikrowellen Bikonus-Breitband-Antenne SBA 9112 *Microwave Biconical Broadband Antenna SBA 9112*

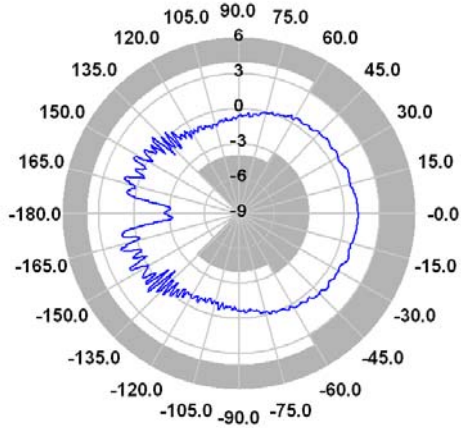

H-Ebene / H-Plane 13 GHz

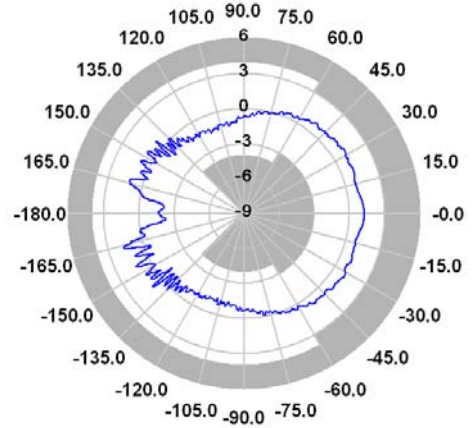

H-Ebene / H-Plane 14 GHz

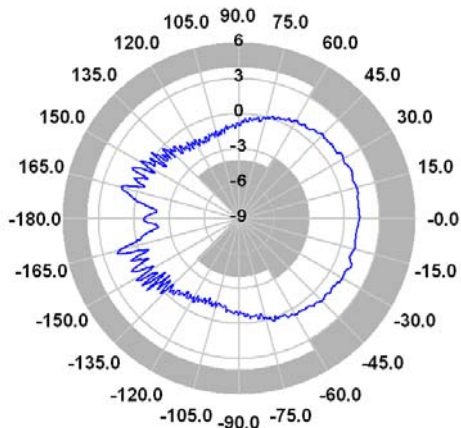

H-Ebene / H-Plane 15 GHz

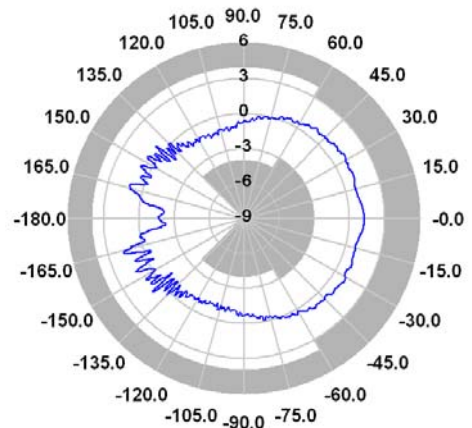

H-Ebene / H-Plane 16 GHz

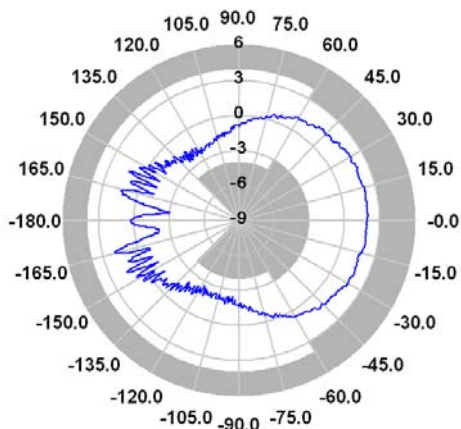

H-Ebene / H-Plane 17 GHz

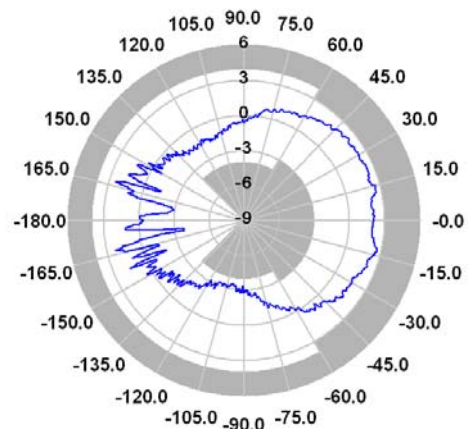

H-Ebene / H-Plane 18 GHz

# SCHWARZBECK MESS - ELEKTRONIK

An der Klinge 29 D-69250 Schönau Tel.: 06228/1001 Fax.: (49)6228/1003

## Mikrowellen Bikonus-Breitband-Antenne SBA 9112 Microwave Biconical Broadband Antenna SBA 9112

### Richtdiagramm H-Ebene

Das Richtdiagramm eines Dipols bzw. einer Bikonusantenne in der H-Ebene ist unter Idealbedingungen kreisförmig. Da für praktische Anwendungen eine Masthalterung sowie das Koaxialkabel der Antenne unvermeidlich sind, entstehen hierdurch Abweichungen vom ideal kreisförmigen Verlauf. Diese Abweichungen sind bis etwa 12 GHz vernachlässigbar, darüber sind Abweichungen gemäß dem untenstehenden Diagramm zu erwarten.

### H-plane pattern

The H-plane directional pattern of a dipole or a biconical antenna under perfect conditions is omnidirectional. Since mast adapter and coaxial cables are essential for real life operation, the pattern deviates somewhat from omnidirectional. The deviations are negligible up to approx. 12 GHz, at higher frequencies deviations according to the diagram below can be expected.

